

3

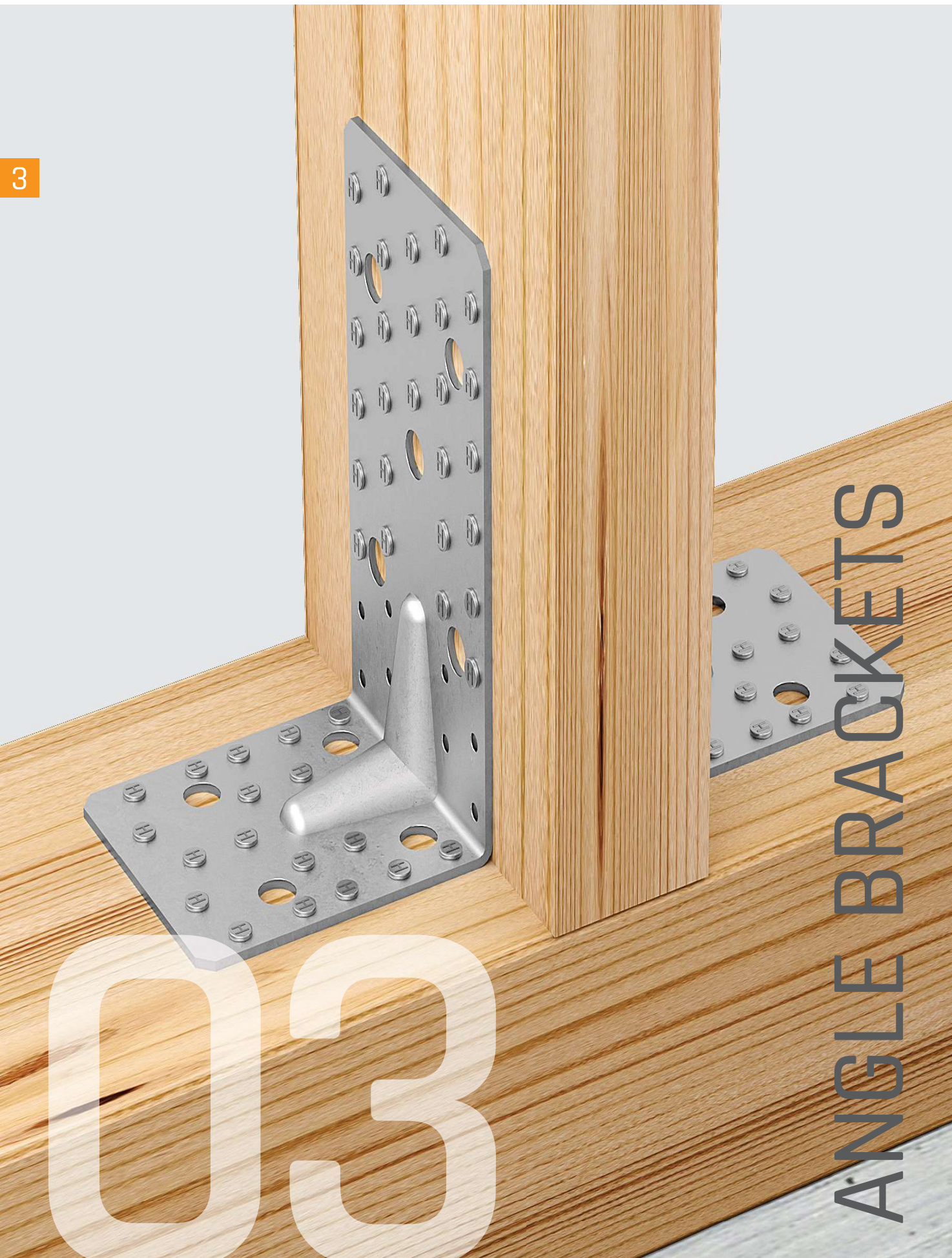

03

ANGLE BRACKETS

ANGLE BRACKETS











































ASSORTMENT

3

					Height [mm]	Length [mm]	Width [mm]	Basics Statik & Diagramme from page	Products & Statik from page	Products Made of V4A from page
ANGLE BRACKET TOP 80/120										
ANGLE BRACKET 70X70X2.0										
ANGLE BRACKET 70X70 GREENLINE										
ANGLE BRACKET TOP KR90E										
ANGLE BRACKET 90X90X2.5										
ANGLE BRACKET 90X90 GREENLINE										
ANGLE BRACKET 100X100X3.0										
ANGLE BRACKET 100X100 GREENLINE										
STRUT CONNECTOR 135 DEGREES										
ANGLE BRACKET TYPE 110/170L										
ANGLE BRACKET KR 3 MM										
ANGLE BRACKET KR 4 MM										
ANGLE BRACKET TYPE 50/80										
ANGLE BRACKET TYPE 110										
ANGLE BRACKET TYPE 55/80										
ANGLE BRACKET TYPE 60/100										
CONSOLE ANGLE										
ANGLE BRACKET TYPE 40/45										
ANGLE BRACKET TYPE 40/90										
ANGLE BRACKET TYPE 40/120										
ANGLE BRACKET TYPE 692										

ANGLE BRACKETS

ASSORTMENT

					Height	Length	Width	Basics Statics & Diagrams from page	Products & Statics from page	Products Made of V4A from page
NAIL PLATE BRACKET										
									148	294
EXTRA THICK 4 MM									110	150
MOUNTING BRACKET							 		110	152
ENTRANCE DOOR BRACKET										158
Z-CONNECTOR							 			158
CHAIR BRACKET										159
ANGLE BRACKET THICK 3-5 MM										159
CONCRETE BRACKET										156
CORNER ANGLE BRACKET										158



CE symbol



Steel with indication of the steel quality and galvanisation



Stainless steel with material number



Timber/timber connection



Timber/concrete-connection



Usage class 1

Moisture content in the building materials that corresponds to a temperature of 20° C and a relative humidity of the ambient air that only exceeds a value of 65% for a few weeks per year, e.g. in the case of buildings that are closed on all sides and heated. Comment: In UC 1, the average moisture content of most softwoods does not exceed 12 %.



Usage class 2

Moisture content in the building materials that corresponds to a temperature of 20° C and a relative humidity of the ambient air that only exceeds a value of 85% for a few weeks per year, e.g. in the case of open buildings covered by a roof. Comment: In UC 2, the average moisture content of most softwoods does not exceed 20 %.



Usage class 3

Includes climatic conditions that lead to higher moisture contents than in UC 2, e.g. structures that are exposed to the weather without protection.

Eurocode 5 / DIN EN 1995-1-1 section 2.3.1.3

ANGLE BRACKETS

STATICS DIAGRAM

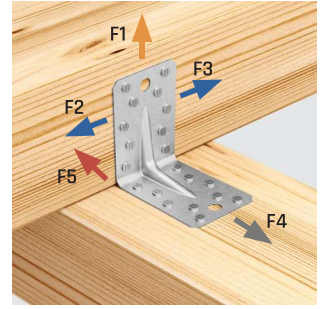

3

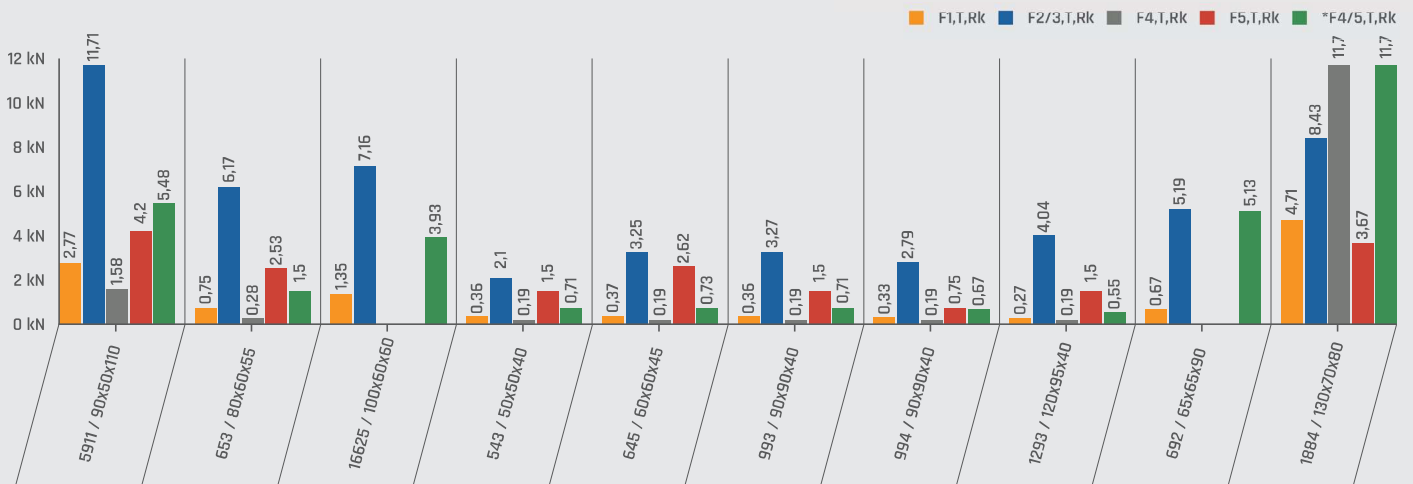
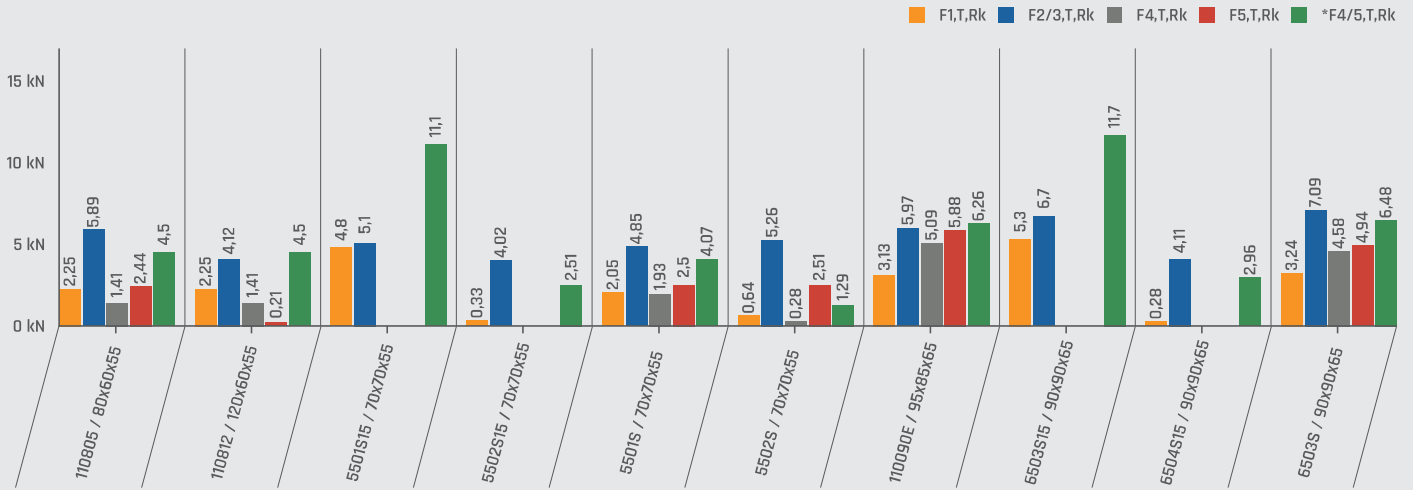

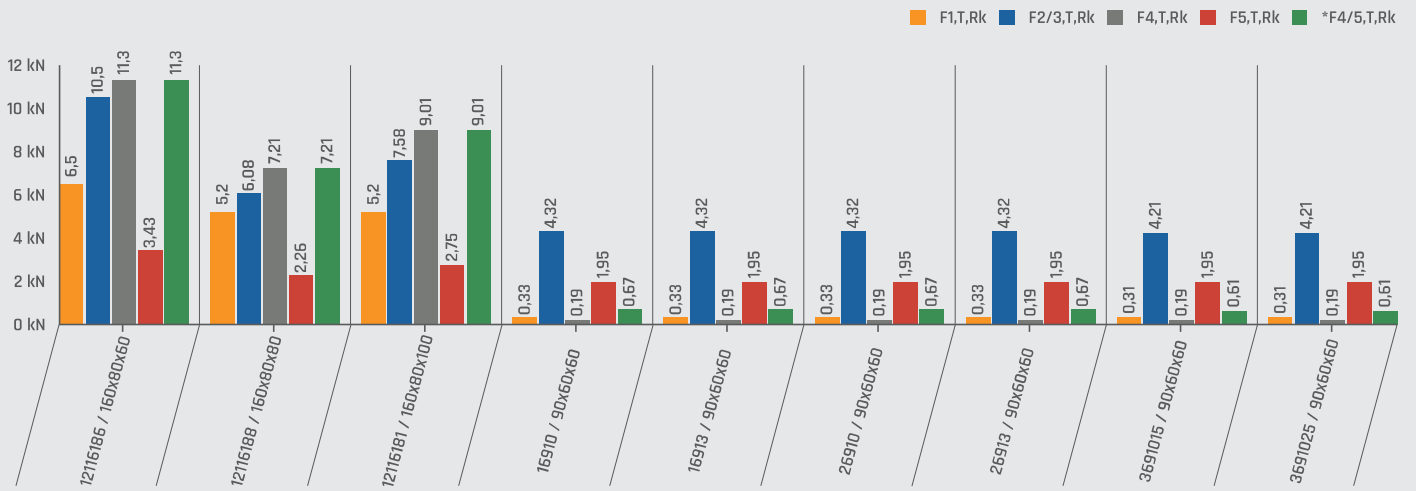
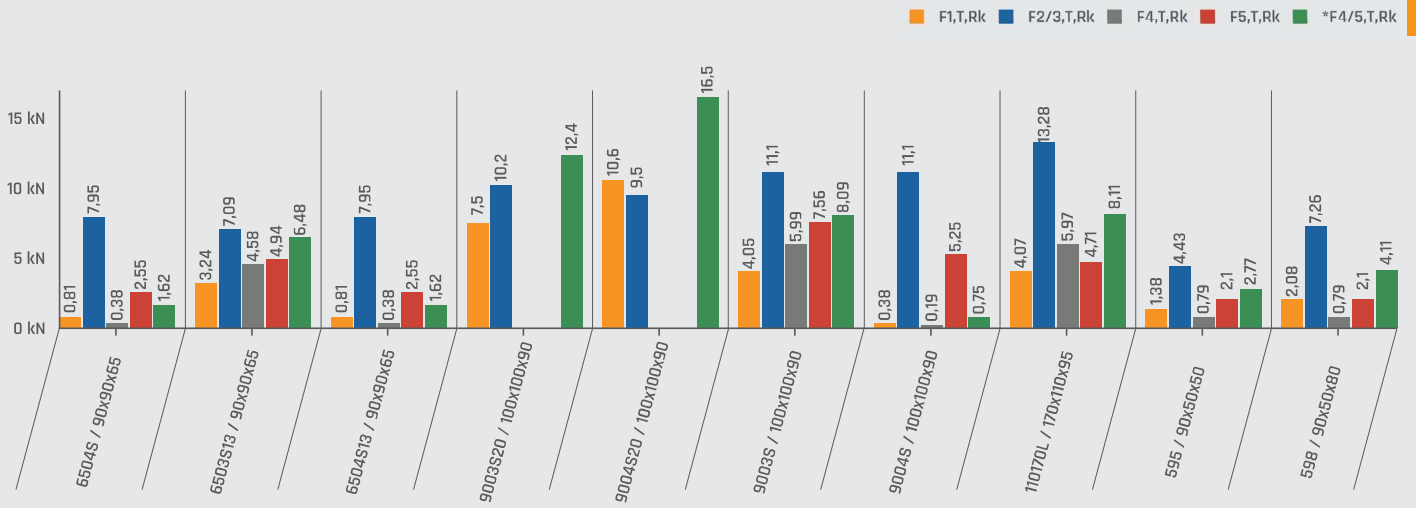

ANGLE BRACKETS

TECHNICAL FEATURES

3

Geometry

H	Height (mm)
L	Length (mm)
B	Width (mm)
S	Material thickness (mm)

Tables

n_o	Number of connecting elements
NB	Nail pattern
Full	Maximum number of connecting elements
Partial	Minimum number of connecting elements

Timber connecting element

$\emptyset_{[mm]}$	Diameter of connecting element
$L_{[mm]}$	Length of connecting element
	Grain direction in the wood component

Connecting element concrete/ steel

Bo	Dowels/bolts
----	--------------

Load directions

$F_1 \uparrow$	Force at a right angle to the connector level, lifting force
$F_2 \leftarrow$	Force in rod direction
$F_3 \rightarrow$	Force in rod direction
$F_4 \nearrow$	Force in direction of the angle bracket
$F_5 \searrow$	Force away from the angle bracket



CE symbol



Steel with indication of the steel quality and galvanisation



Stainless steel with material number



Timber/timber connection



Timber/concrete-connection



Usage class 1

Moisture content in the building materials that corresponds to a temperature of 20° C and a relative humidity of the ambient air that only exceeds a value of 65% for a few weeks per year, e.g. in the case of buildings that are closed on all sides and heated.
Comment: In UC 1, the average moisture content of most softwoods does not exceed 12 %.



Usage class 2

Moisture content in the building materials that corresponds to a temperature of 20° C and a relative humidity of the ambient air that only exceeds a value of 85% for a few weeks per year, e.g. in the case of open buildings covered by a roof.
Comment: In UC 2, the average moisture content of most softwoods does not exceed 20 %.



Usage class 3

Includes climatic conditions that lead to higher moisture contents than in UC 2, e.g. structures that are exposed to the weather without protection.
Eurocode 5 / DIN EN 1995-1-1 section 2.3.1.3

Design

$F_{1,Ed}$	Design load for load direction 1 in kN
$F_{2/3,Ed}$	Design load for load direction 2 or 3 in kN
$F_{4,Ed}$	Design load for load direction 4 in kN
$F_{5,Ed}$	Design load for load direction 5 in kN
$F_{4/5,Ed}$	Design load for load direction 4 or 5 in kN
$F_{1,Rk}$	Characteristic value of the load capacity in load direction 1 for one or for two angle brackets in kN
$F_{2/3,Rk}$	Characteristic value of the load capacity in load direction 2 or 3 for one or for two angle brackets in kN
$F_{4,Rk}$	Characteristic value of the load capacity in load direction 4 for one angle bracket in kN
$F_{5,Rk}$	Characteristic value of the load capacity in load direction 5 for one angle bracket in kN
$F_{4/5,Rk}$	Characteristic value of the load capacity in load direction 4 or 5 for two angle brackets in kN
$F_{1,Rd}$	Design value of the load capacity in load direction 1 for one or for two angle brackets in kN
$F_{2/3,Rd}$	Design value of the load capacity in load direction 2 or 3 for one or for two angle brackets in kN
$F_{4,Rd}$	Characteristic value of the load capacity in load direction 4 for one angle bracket in kN
$F_{5,Rd}$	Characteristic value of the load capacity in load direction 5 for one angle bracket in kN
$F_{4/5,Rd}$	Characteristic value of the load capacity in load direction 4 or 5 for two angle brackets in kN
$F_{i,Ed}$	Design value of load capacity for one or two angle brackets for the respective load direction "i" (i = 1 to 5) in kN
$F_{i,Rk,T}$	Characteristic value of the load-bearing capacity of the sheet steel-timber connection with GH threaded/anchor nails for the 'i' (i = 1 to 5) in kN respective load direction 'i' (i = 1 to 5) in kN
$F_{i,Rk,S}$	Characteristic value for steel load capacity of the bracket (table value „S“ oder $F_{Rk,S}$ bzw. $F_{Rd,S}$) for the respective load direction "i" (i = 1 to 5) in kN
k_{mod}	Modification factor for load impact duration and usage class
$\gamma_{M,T}$	Partial safety factor for timber (for Germany: 1.3)
$\gamma_{M,S}$	Partial safety factor for steel for cross-section stresses (for Germany: 1.0)

Dowel design

$k_{i,t,ax}$	Coefficient for calculating the axial load-bearing capacity per bolt, for connecting the bracket to concrete or steel components for the respective Load direction "i" (i = 1 to 5)
$k_{i,t,v}$	Coefficient for calculating the shear load-bearing capacity per bolt, for connecting the bracket to concrete or steel components for the respective Load direction "i" (i = 1 to 5)
$F_{i,Ed}$	Design load on one or two angle brackets for the respective load direction "i" (i = 1 to 5) in kN
$F_{i,Rd}$	Design value of load capacity on one or two angle brackets for the respective load direction "i" (i = 1 to 5) in kN
$F_{i,Ed,B}$	Design value for one bolt or one anchor for the respective load direction "i" (i = 1 to 5) in kN
$F_{i,Rd,B}$	Design value of the load-bearing capacity of the entire connection to concrete or steel with bolts or anchors for the respective Load direction 'i' (i = 1 to 5) in kN (calculation must be carried out separately and is based on the respective approval and standard of the bolts or anchors)

ANGLE BRACKETS

APPLICATIONS

3

Application:

Timber/timber; timber/concrete, steel connections

Materials:



Material thicknesses:

1.5 / 2.0 / 2.5 / 3.0 / 4.0 / 6.0 / 8.0 mm

More on request.

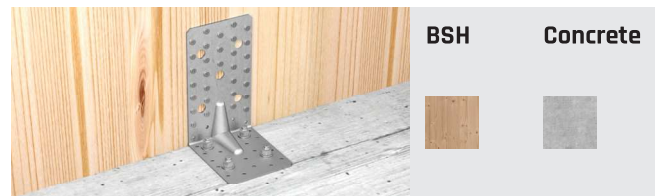
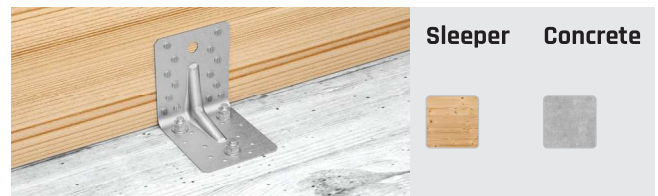
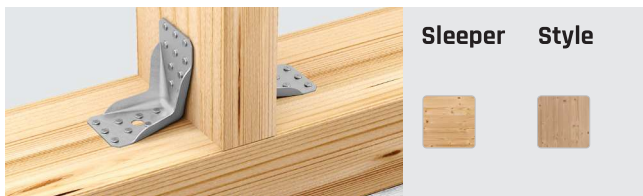

For use in usage classes

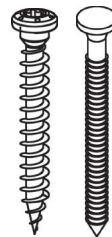

Connecting element:

GH threaded nails 4.0 x 35 / 40 / 50 / 60 / 75 / 100 mm
GH screws 5.0 x 25 / 35 / 40 / 50 / 60 / 70 mm

Bolt, dowel or concrete anchor M10, M12

Connecting elements from page 274

ANGLE BRACKETS

LOAD DIRECTIONS

3

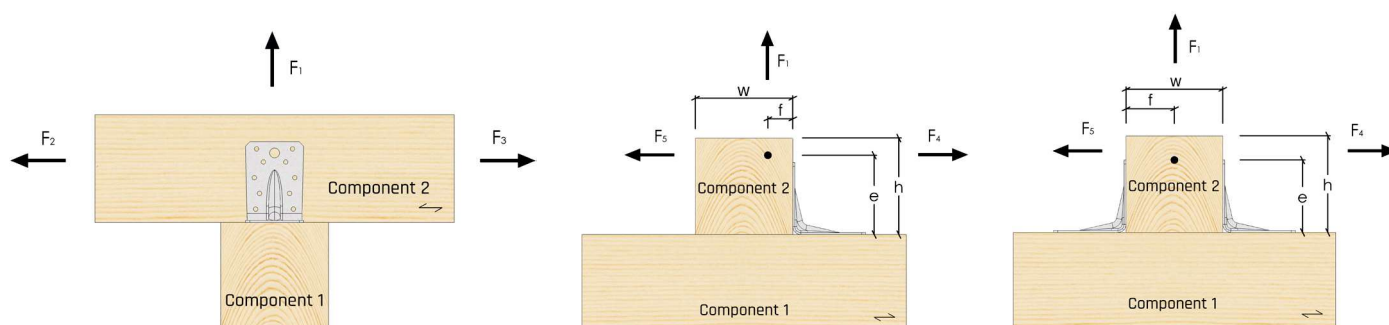

Load F_1 :

For the load-bearing capacity of a bracket, the load is applied at spacing f from the contact surface between the bracket and the timber beam is applied (Figure 2). If it is assumed that the timber component is prevented from rotating or if two console angles are arranged, then the eccentricity is $f = 0$.

Load $F_{2/3}$

Calculation of the load-bearing capacity of one or two angle brackets that are loaded with a force in the direction of the axis of component 2 (Fig. 1).

Load $F_4 / F_5 / F_{4/5}$

In all three cases, the load is applied at a distance e from the contact surface between component 1 and component 2 (Figure 2). The load cases are considered as a combination of two base load cases.

The first base load case is the lateral load with forces $n F_4, F_5$ or $F_{4/5}$ with $e = 0$.

For the arrangement with an angle bracket, the rotation of component 2 is taken into account.

For the arrangement with two angle brackets, the rotation of component 2 is prevented and the load on the beam due to the moment is calculated as the lifting force $F_1 = F_{4/5} \times e/w$, w is thereby the width of component 2

Nail patterns

Partial and full nail fitting or partial and full screw fitting
See nail pattern for the product

Connection over intermediate layers

The characteristic load capacities for the connection with angle brackets indicated in the tables also apply to an intermediate layer between the angle bracket and timber component. The following conditions must be met:

- The intermediate layer must be connected to the timber component without being able to be moved.
- The insert depth of the profiled area of the nail or the thread length of the screw in the timber component must be the same or greater.
- For this, a correspondingly long connecting element must be used.
- The characteristic perforation strength $f_{h,k}$ of the connecting element in the intermediate layer must be the same or greater.

Determination of load capacity

The load capacity of connections with angle brackets $F_{i,Rd}$ for the respective load direction "i" ($i = 1$ to 5) corresponds to the smallest value of:

- The load capacity of the steel sheet-timber connection with GH threaded/anchor nails $F_{i,Rd,T}$
- Steel load capacity of the bracket $F_{i,Rd,S}'$
- Load-bearing capacity of the connection to concrete or steel with bolts or anchors under consideration of the coefficient $k_{t,ax}$ or $k_{t,v}$, see section 4.

$$F_{i,Rd} = \min \left\{ \frac{k_{mod} \cdot F_{i,Rk,T}}{\gamma_{M,T}}; \frac{F_{i,Rk,S}}{\gamma_{M,S}}; F_{i,Rd,B} \right\}$$

The increased load capacity values of the GH threaded/anchor nails according to ETA-13/0523 apply.
The values of EN14592 apply to angle brackets made of stainless steel.

Connection timber- concrete/ steel

The design load of the respective load direction "i" (i = 1 to 5) $F_{i,Ed,B}$ for one bolt or for one anchor is calculated as follows:

$$F_{i,Ed,B} = k_{i,t,ax} \times F_{i,Ed} \quad \text{for axial stress on the bolt or anchor}$$

$$F_{i,Ed,B} = k_{i,t,w} \times F_{i,Ed} \quad \text{for lateral stress on the bolt or anchor}$$

Load in one direction

In case of sole impact of load components F_1 , $F_{2/3}$, F_4 or F_5 or $F_{4/5}$ the proof of interaction must be provided in the following form:

$$\frac{F_{i,Ed}}{F_{i,Rd}} \leq 1$$

Load in several directions

In case of simultaneous impact of load components F_1 , $F_{2/3}$, F_4 or F_5 and $F_{4/5}$ the proof of interaction must be provided as follows:
For a bracket, the loads F_4 and F_5 never take effect at the same time.

For one bracket:

$$\left(\frac{F_{1,Ed}}{F_{1,Rd}}\right)^2 + \left(\frac{F_{2/3,Ed}}{F_{2/3,Rd}}\right)^2 + \left(\frac{F_{4,Ed}}{F_{4,Rd}}\right)^2 + \left(\frac{F_{5,Ed}}{F_{5,Rd}}\right)^2 \leq 1$$

For two brackets:

$$\left(\frac{F_{1,Ed}}{F_{1,Rd}}\right)^2 + \left(\frac{F_{2/3,Ed}}{F_{2/3,Rd}}\right)^2 + \left(\frac{F_{4/5,Ed}}{F_{4/5,Rd}}\right)^2 \leq 1$$

General information

The load capacities apply to timbers with a characteristic raw density of 350 kg/m³.

Curvatures of the timber components and joist edges in the area of the angle brackets are not permitted - the wood must be sharp-edged in the area of the bracket.

There must be proof that no gaps occur in the timber component for all load directions according to EN 1995 or an equivalent national standard.

Minimum spacing according to EN 1995-1-1

[mm]		Force parallel to the grain	Force at a right angle to the grain	Force under the bracket α to the grain
		($\alpha = 0^\circ$)	($\alpha = 90^\circ$)	(α any)
a_1	in grain direction	28	14	(14+14 x cos α)
a_2	Right angle to the grain direction	14	14	14
$a_{3,t}$	End grain with stress	60	40	(40 + 20 x cos α)
$a_{3,e}$	End grain without stress	40	40	40
$a_{4,t}$	Loaded edge	20	28	(20 + 8 x sin α)
$a_{4,e}$	Unloaded edge	20	20	20

Nails \emptyset 4 mm, without pilot drilling, in nail plates, $p_k \leq 420$ kg/m³

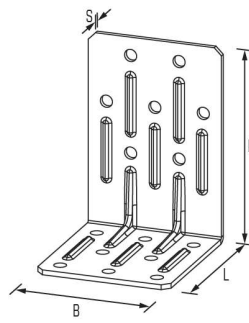

ANGLE BRACKETS

TOP 80 / TOP 120

3

Art. No.	Dimensions [mm]						nN	EAN	Weight	Pallet	PU		
	H	x	L	x	W(B)	x							
110805	80	x	60	x	55	x	2,0	15	110805	0.106	7200	100	■
110812	120	x	60	x	55	x	2,0	15	110812	0.136	6000	100	■



The TOP 80 and TOP 120 angle brackets are characterised by their high stability, which is achieved by the special ribs that do not interfere with processing. Full nail fitting is always possible due to the optimised hole pattern.

Assembly

- Short leg on the continuous timber
- From a timber width of 80 mm.
- To timber/timber, timber/board materials

TOP 80 / TOP 120

Art. No.	Dimensions [mm]				n _a	NB	VM	Timber / Timber									
	H	L	W(B)	T(S)				F _{1,T,Rk}	F _{1,S,Rk}	F _{2/3,T,Rk}	F _{4,T,Rk}	F _{4,S,Rk}	F _{5,T,Rk}	F _{5,S,Rk}	*F _{4/5,T,Rk}	*F _{4/5,S,Rk}	
110805	80	60	55	2,0	15	Full	4,0x40	1,35	1,71	4,46	0,84	0,66	1,46	1,07	2,69	3,42	
							4,0x60	2,25	1,71	5,89	1,41	0,66	2,44	1,07	4,50	3,42	
					-	Partial	4,0x40	-	-	-	-	-	-	-	-	-	-
							4,0x60	-	-	-	-	-	-	-	-	-	-
110812	120	60	55	2,0	15	Full	4,0x40	1,35	1,71	3,04	0,84	1,07	0,13	0,04	2,69	3,42	
							4,0x60	2,25	1,71	4,12	1,41	1,07	0,21	0,04	4,50	3,42	
					-	Partial	4,0x40	-	-	-	-	-	-	-	-	-	-
							-	-	-	-	-	-	-	-	-	-	-

Values are valid for 1 angle bracket (* 2 angle brackets opposite each other), 6H nail, ρ_k = 350 kg/m³, f = 0 mm, e = 40 mm, b = 80 mm, unit of length in mm, unit for force in kN.
 For 2 angle brackets opposite each other, the values F_{1,T,Rk}, F_{1,S,Rk}, F_{2/3,T,Rk} can be doubled.